

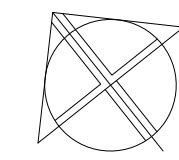

PARK VIEW
COMPETITION



پارک مهرگان

دیوار اطراف مجتمع آپارتمانی

دیوار اطراف مجتمع آپارتمانی

دیوارسازی

بلوار رسالت شمالی

خیابان ۳۰ متری

دیوارسازی

دیوارسازی

دیوارسازی

همسایه

گذر (بن بست)

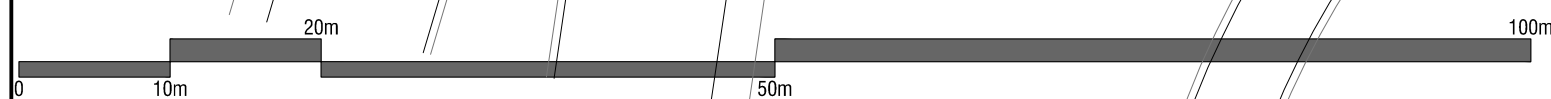



PARK VIEW
COMPETITION

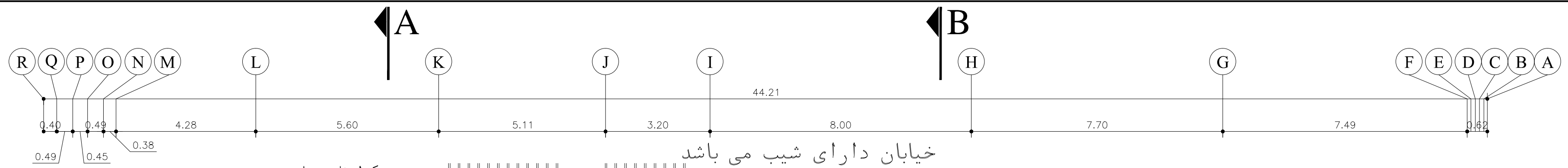

خیابان دارای شیب می باشد

کد ارتفاعی مبنا
+0.00

+3.21

+3.21

+3.21

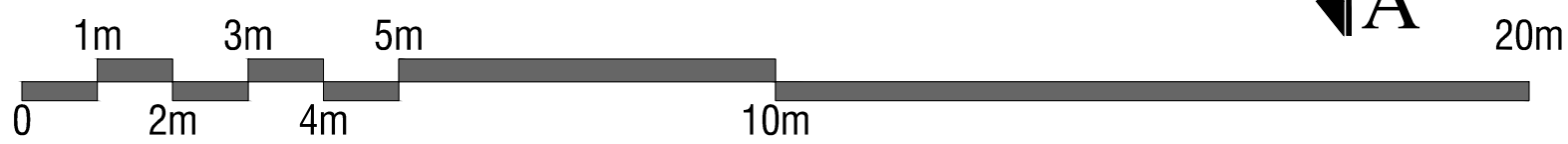
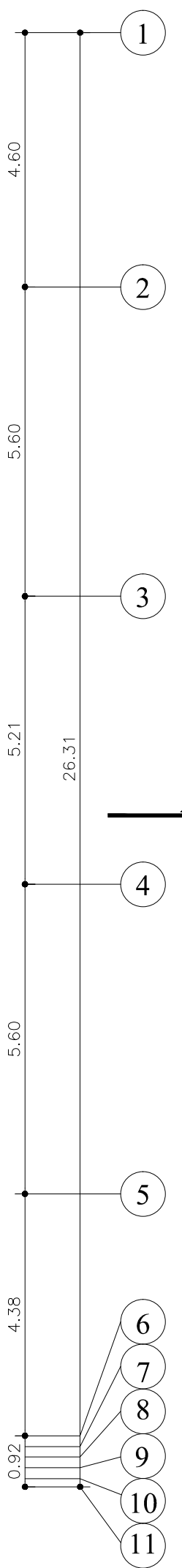

02/19

پلان زیرزمین -1



PARK VIEW
COMPETITION

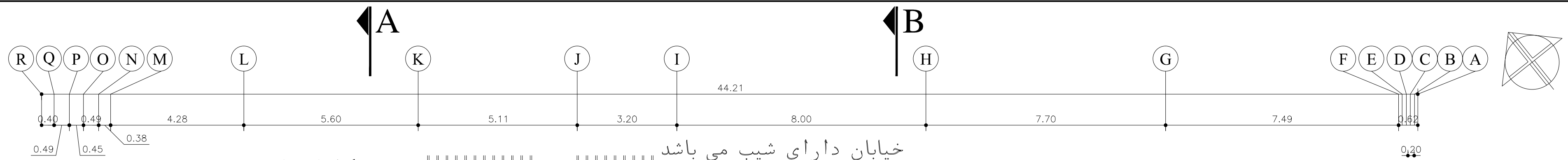

خیابان دارای شیب می باشد

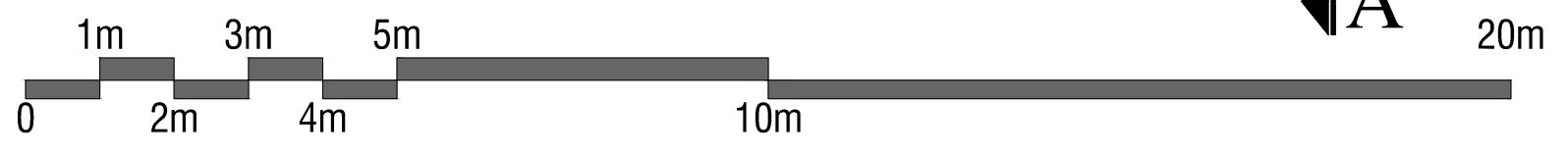
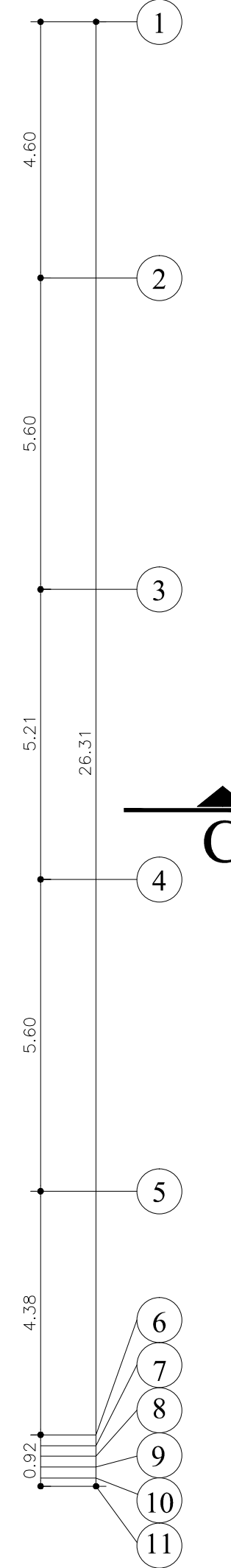
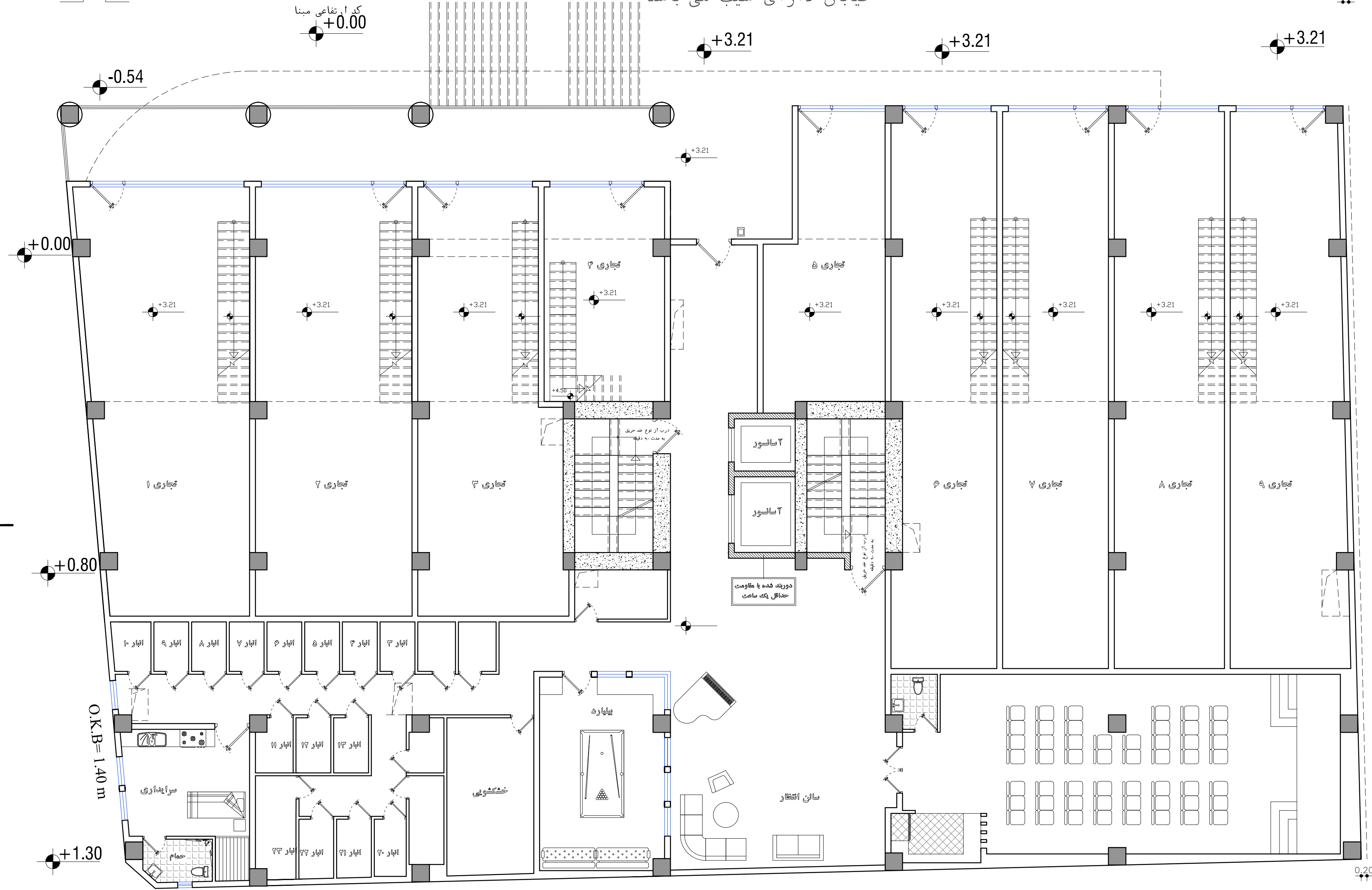

03/19
پلان همگف



PARK VIEW
COMPETITION

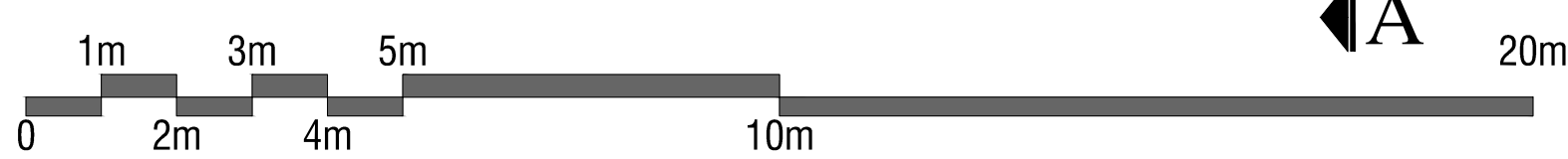
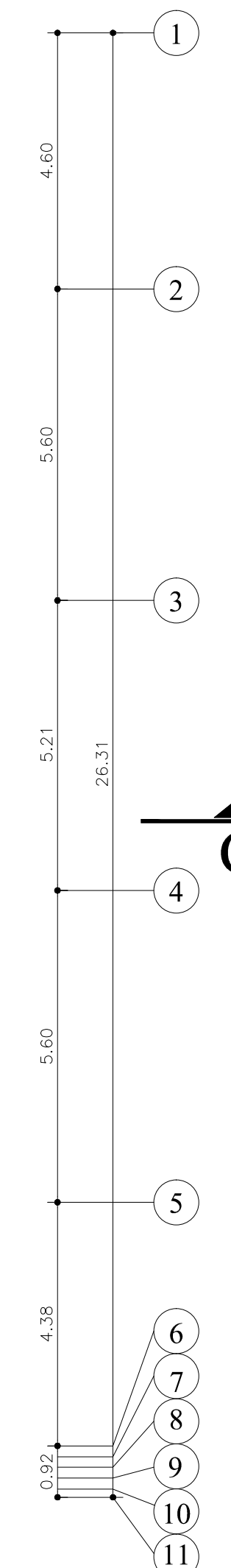
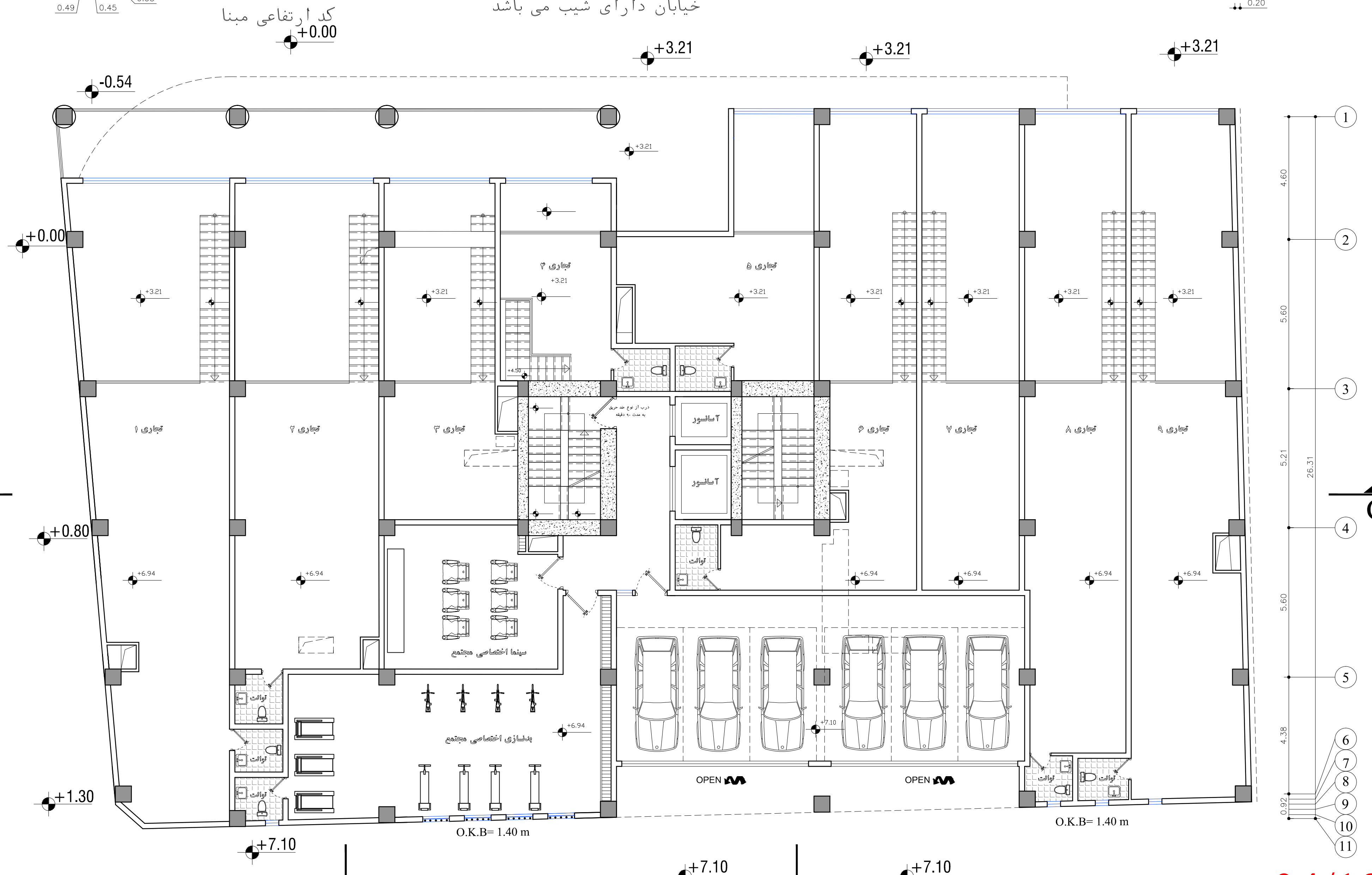

04/19
پلان نیم طبقه همکف



PARK VIEW
COMPETITION

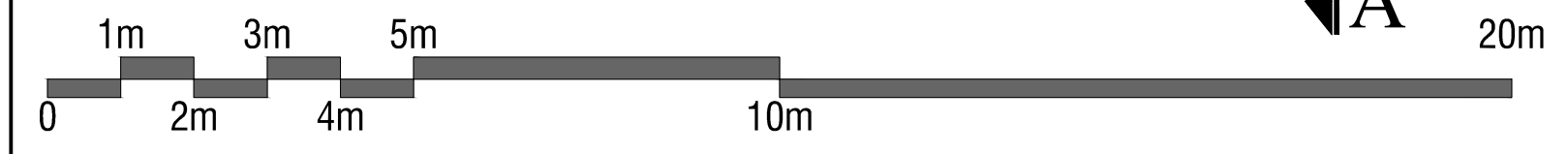
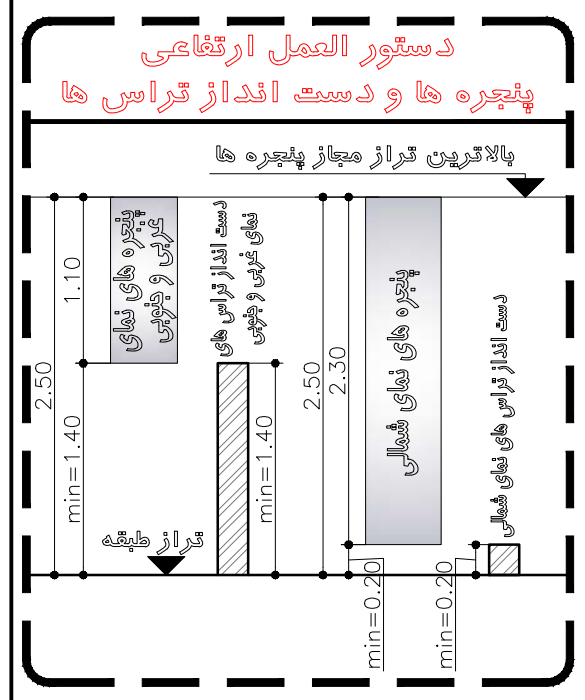
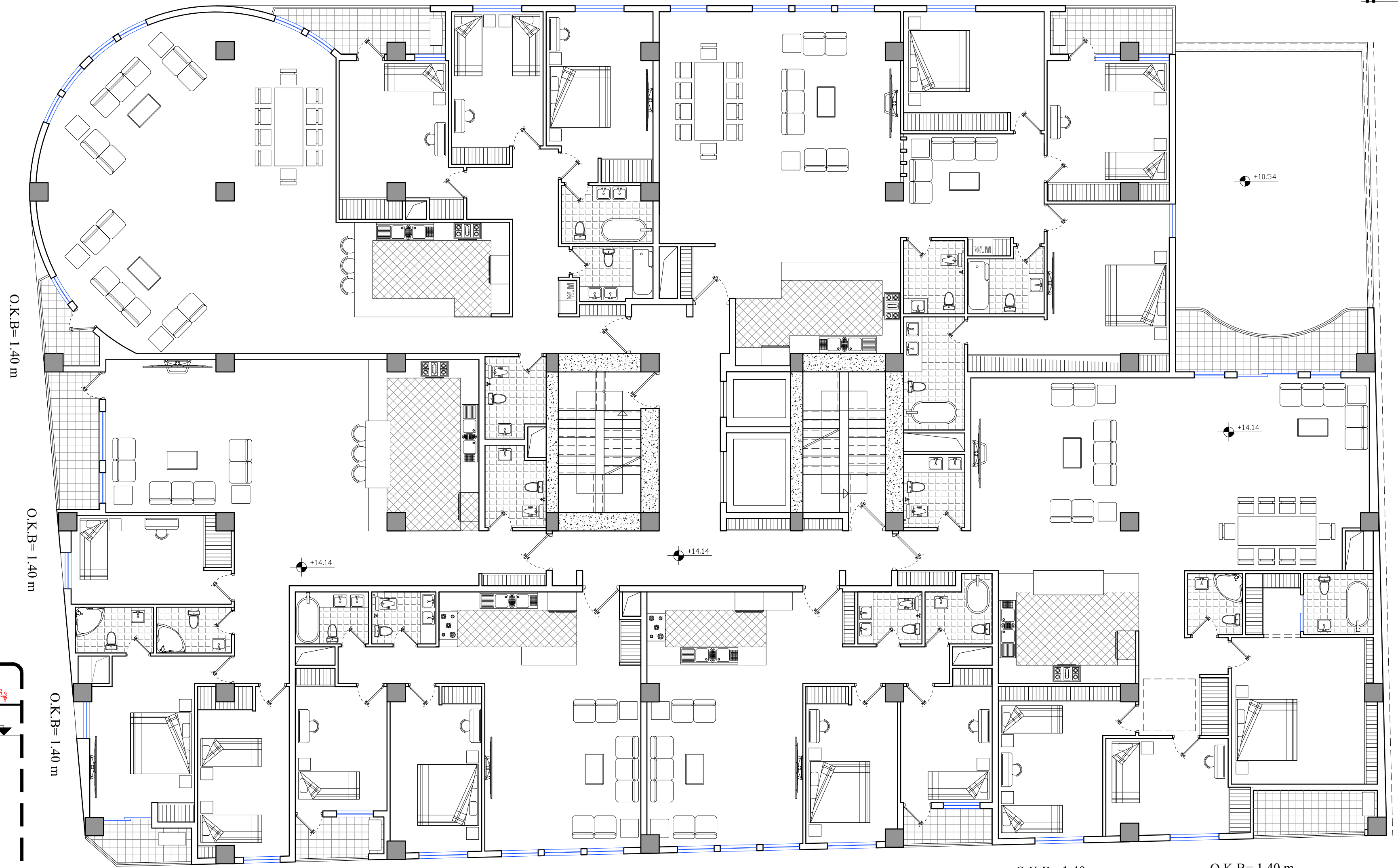
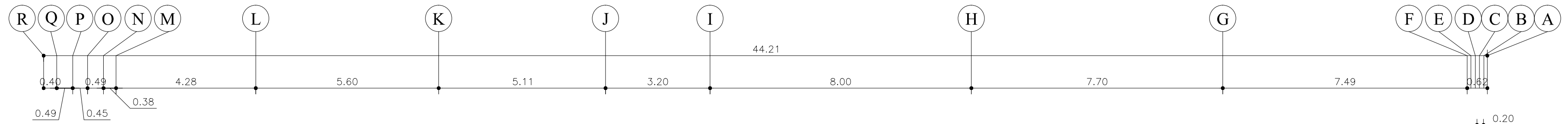
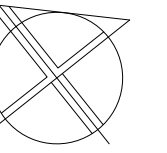

06/19

پلان مبلمان طبقه دوم



PARK VIEW
COMPETITION

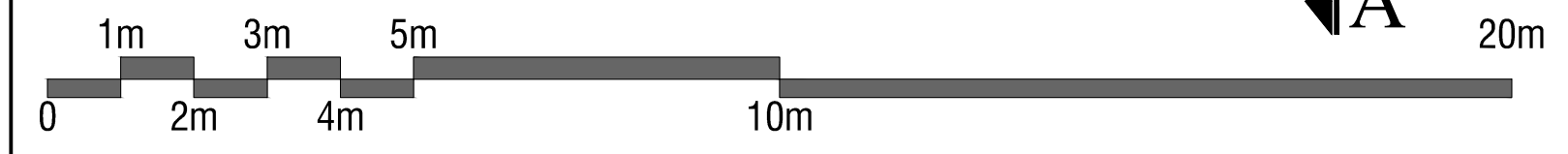
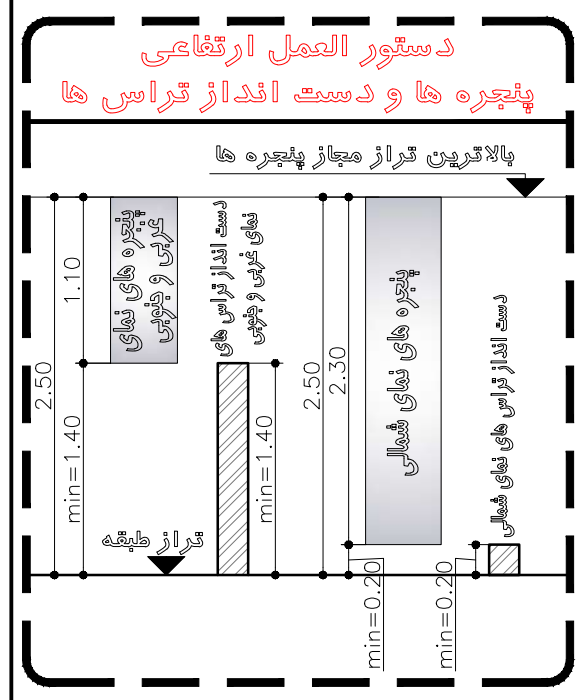
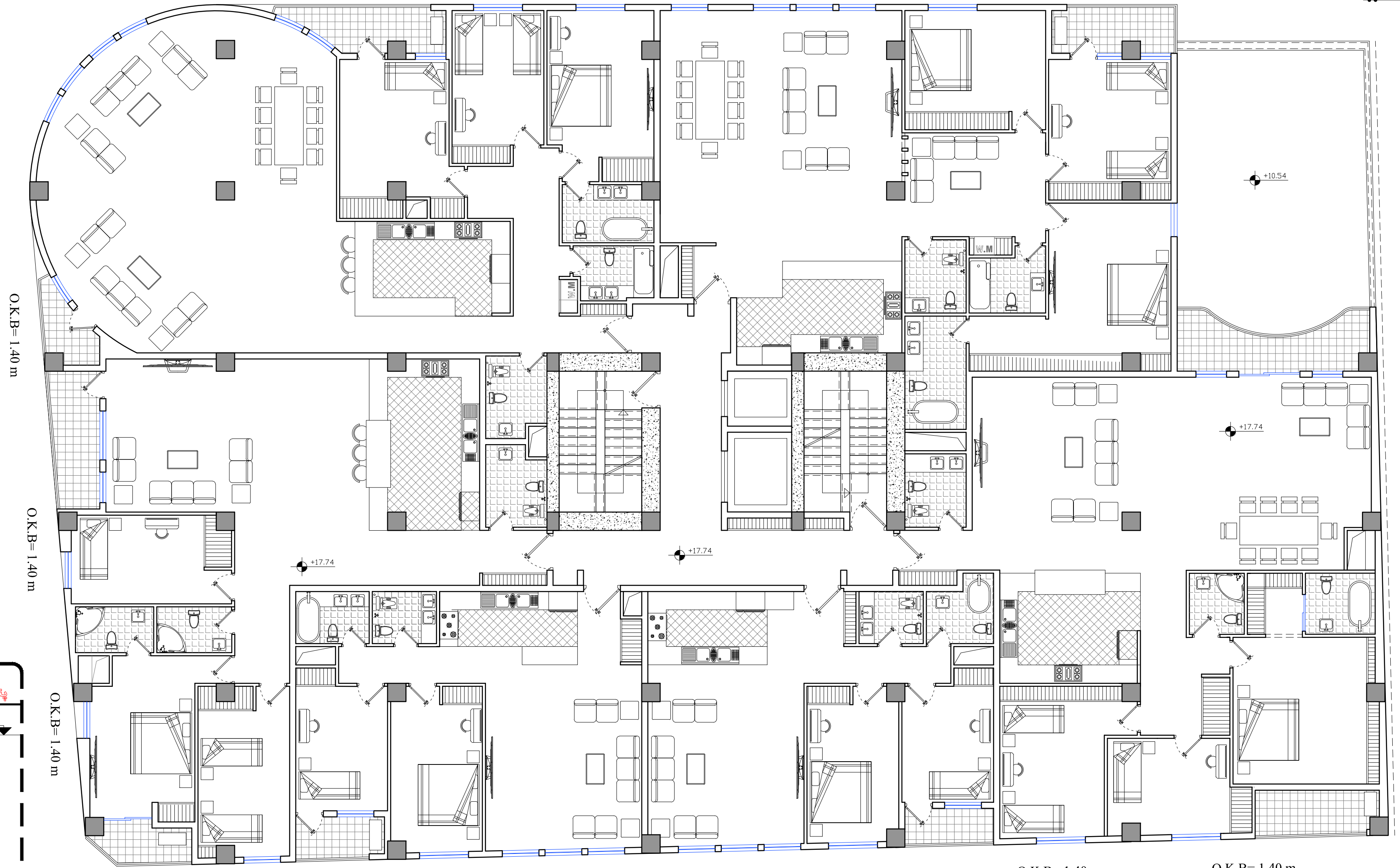
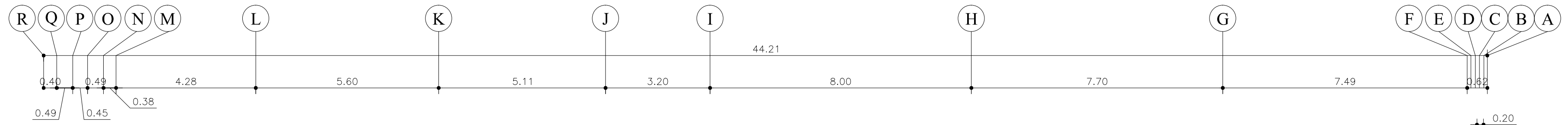
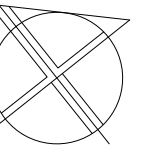

07/19
پلان مبلمان طبقه سوم



PARK VIEW
COMPETITION

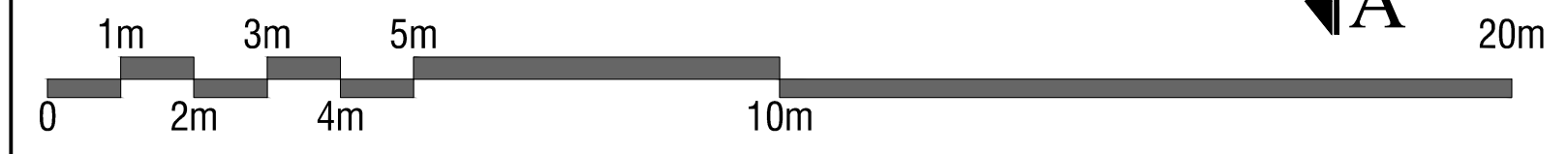
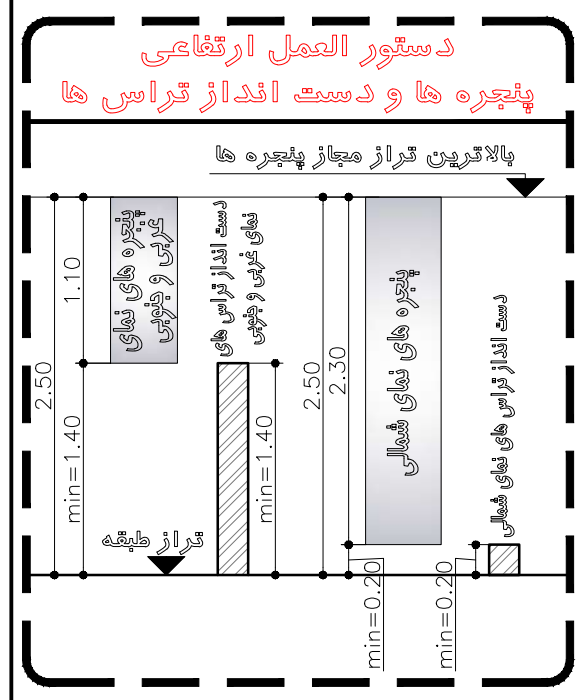
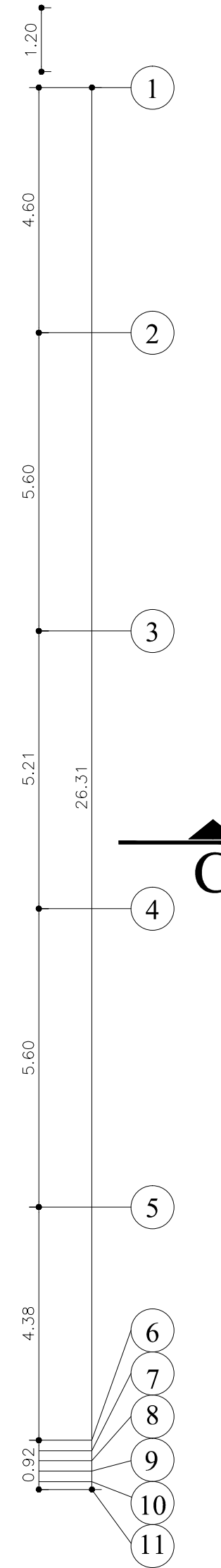
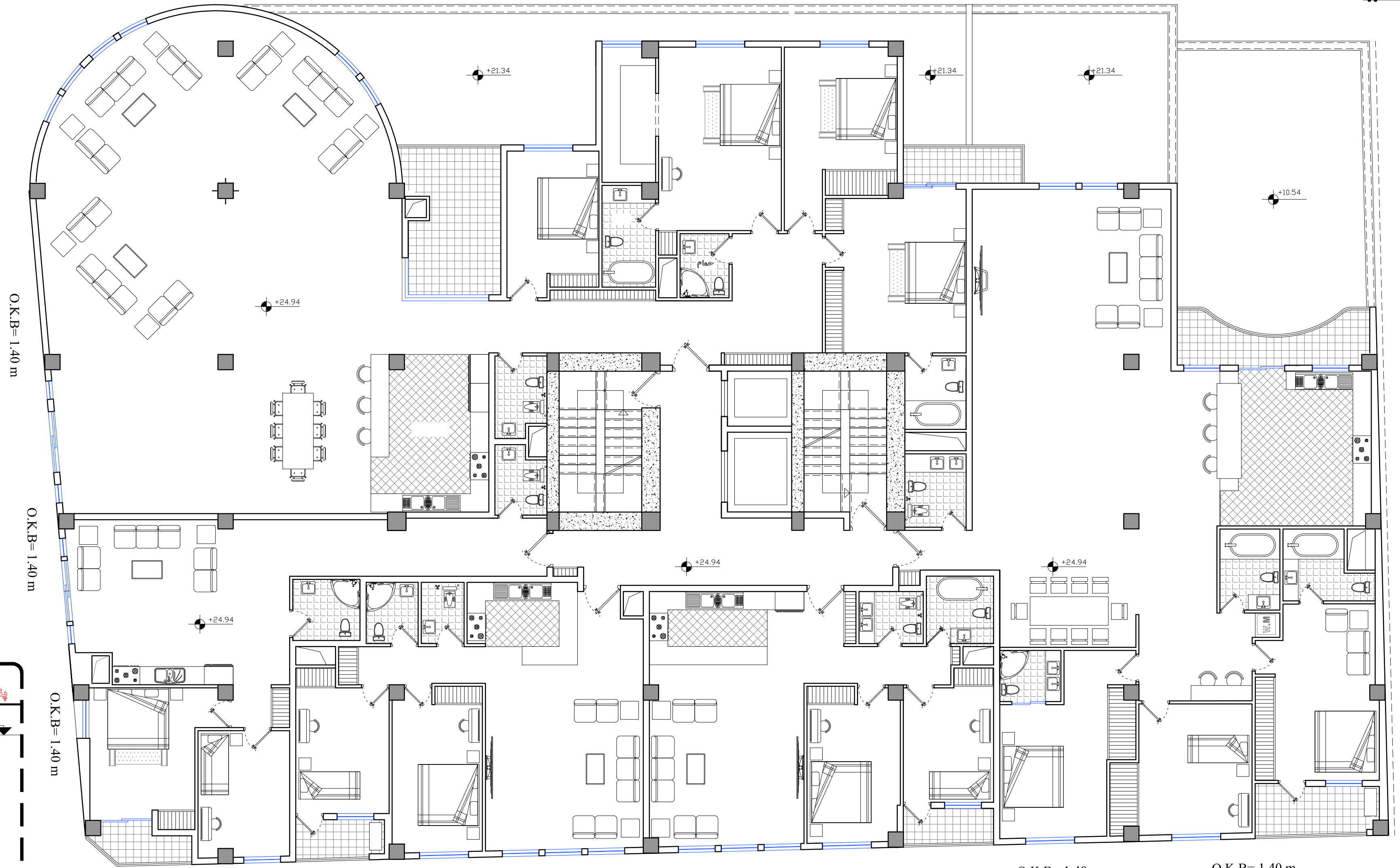
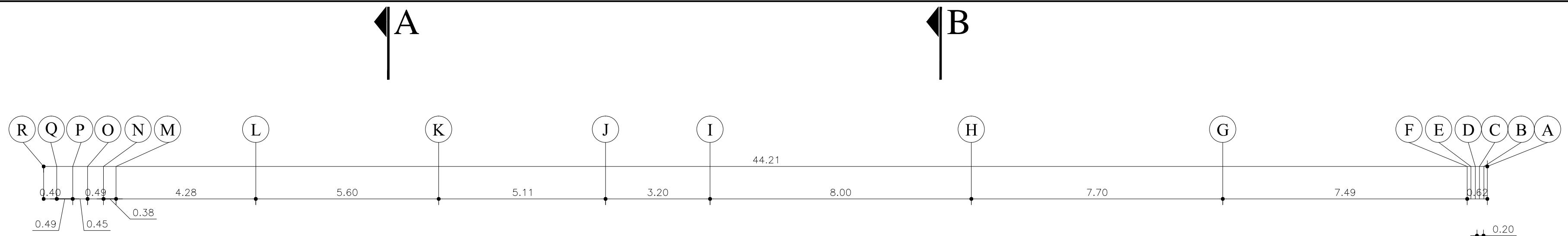
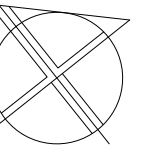

09/19

پلان میلمان طبقه پنجم

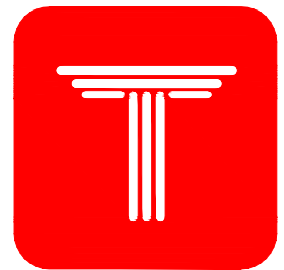

PARK VIEW
COMPETITION

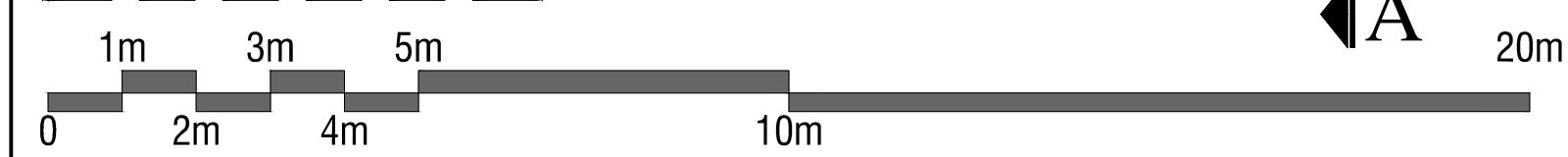
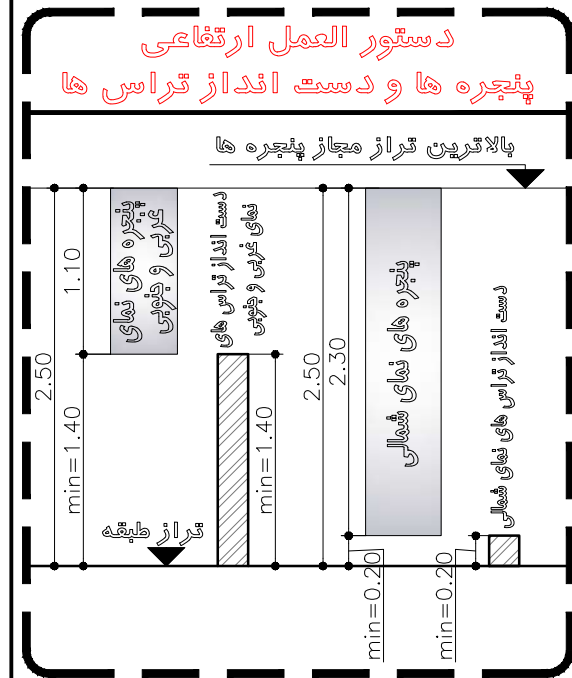
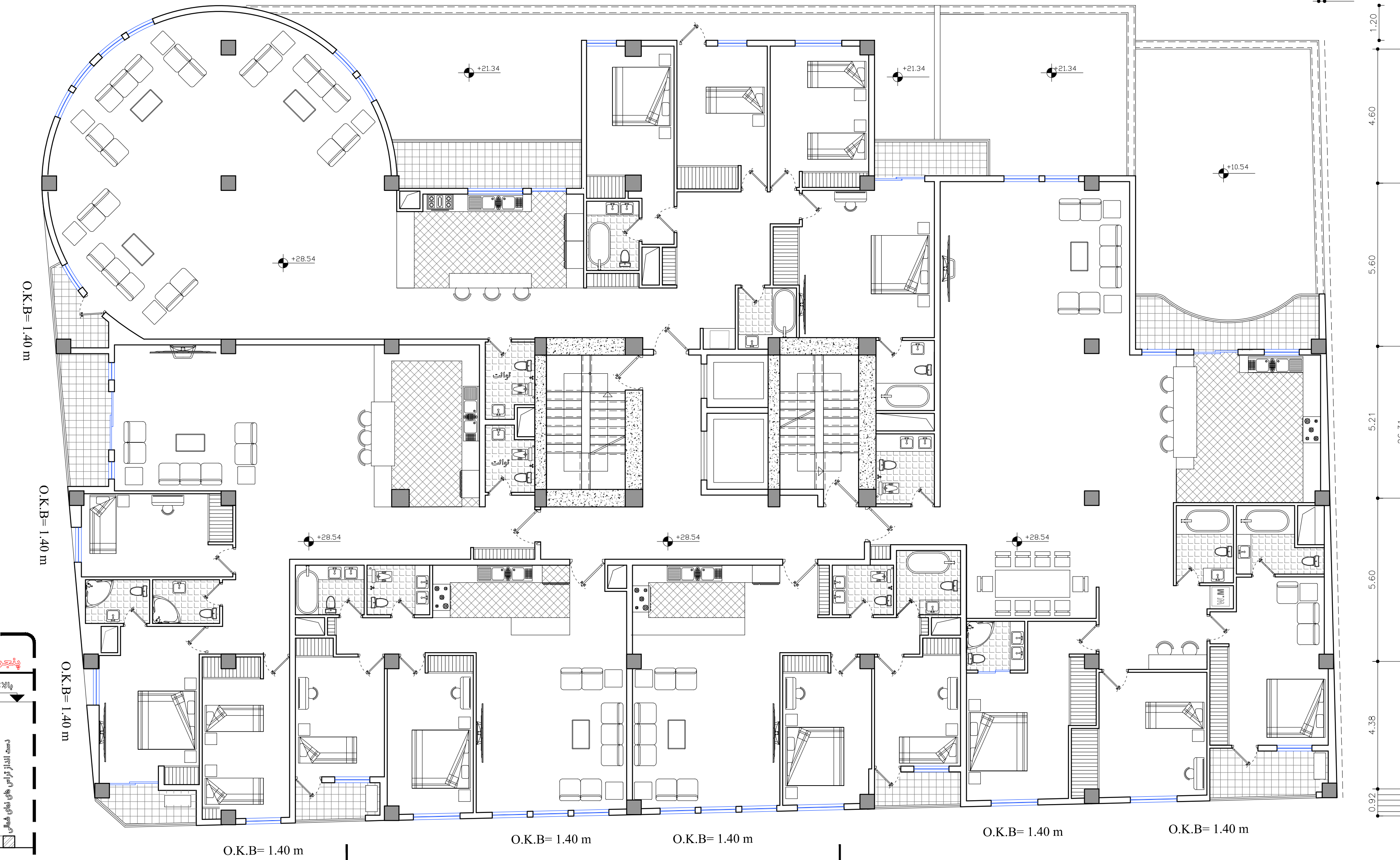
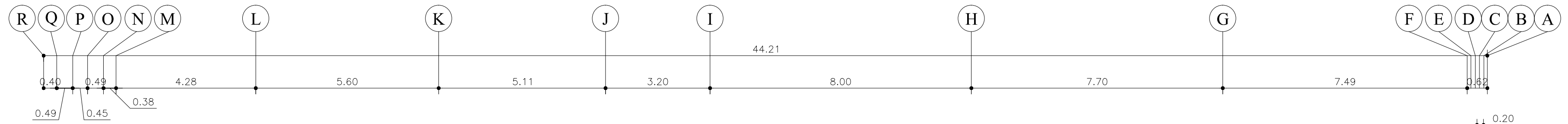
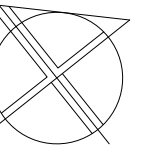

10/19

پلان میلمان طبقه ششم



PARK VIEW
COMPETITION

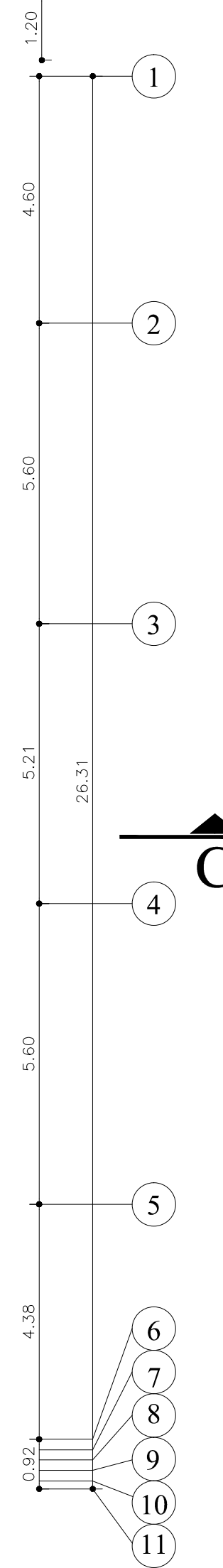
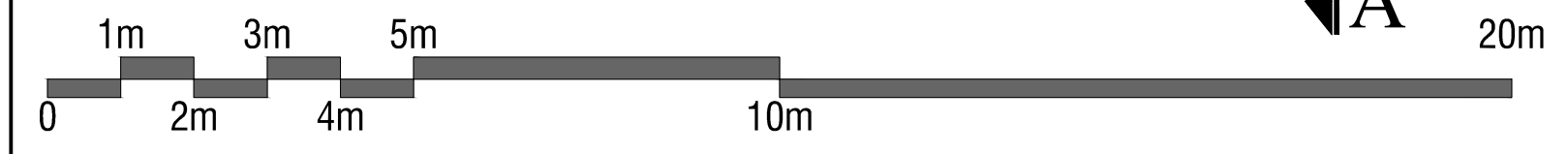
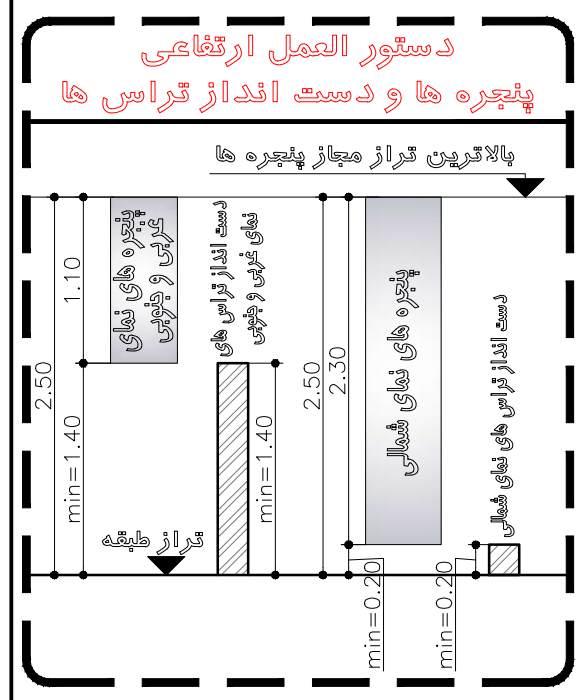
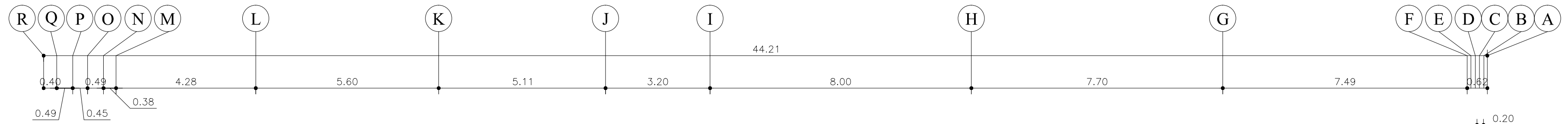
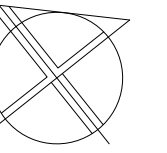

11/19
پلان میلمان طبقه هفتم

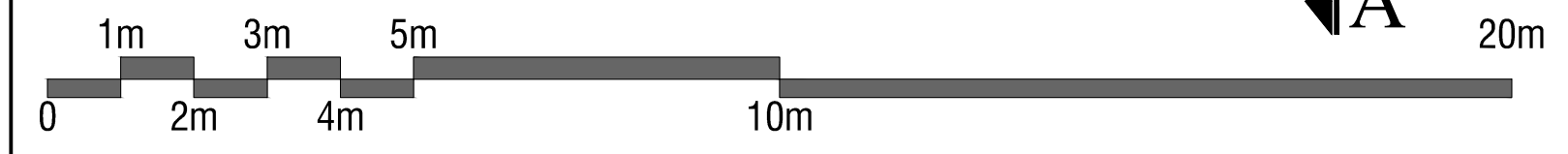
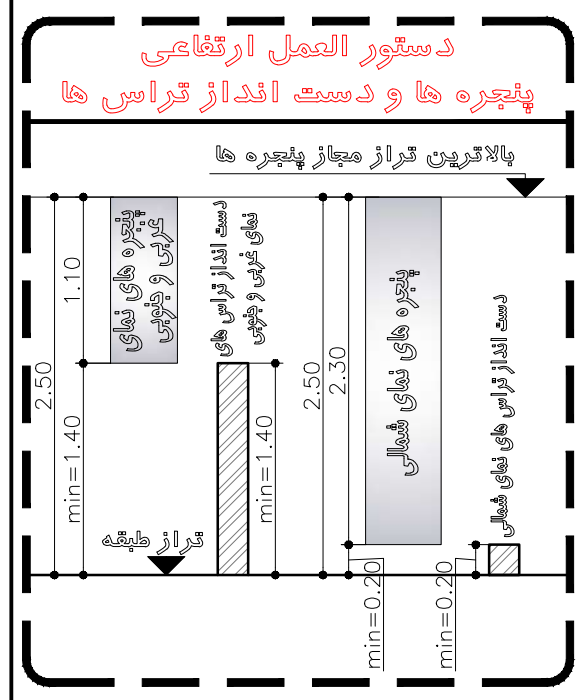
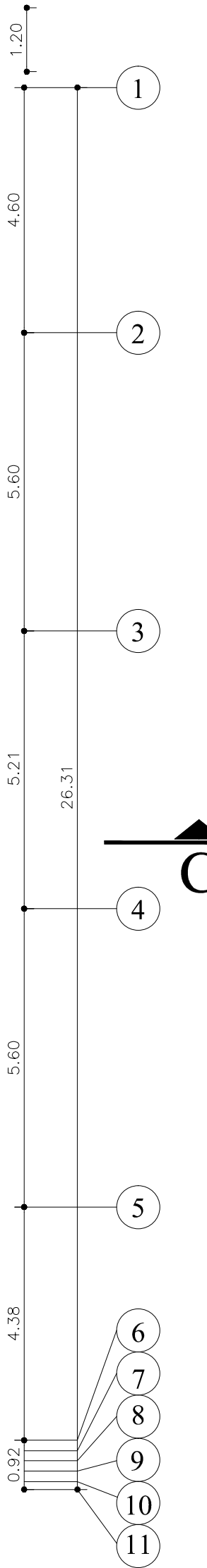
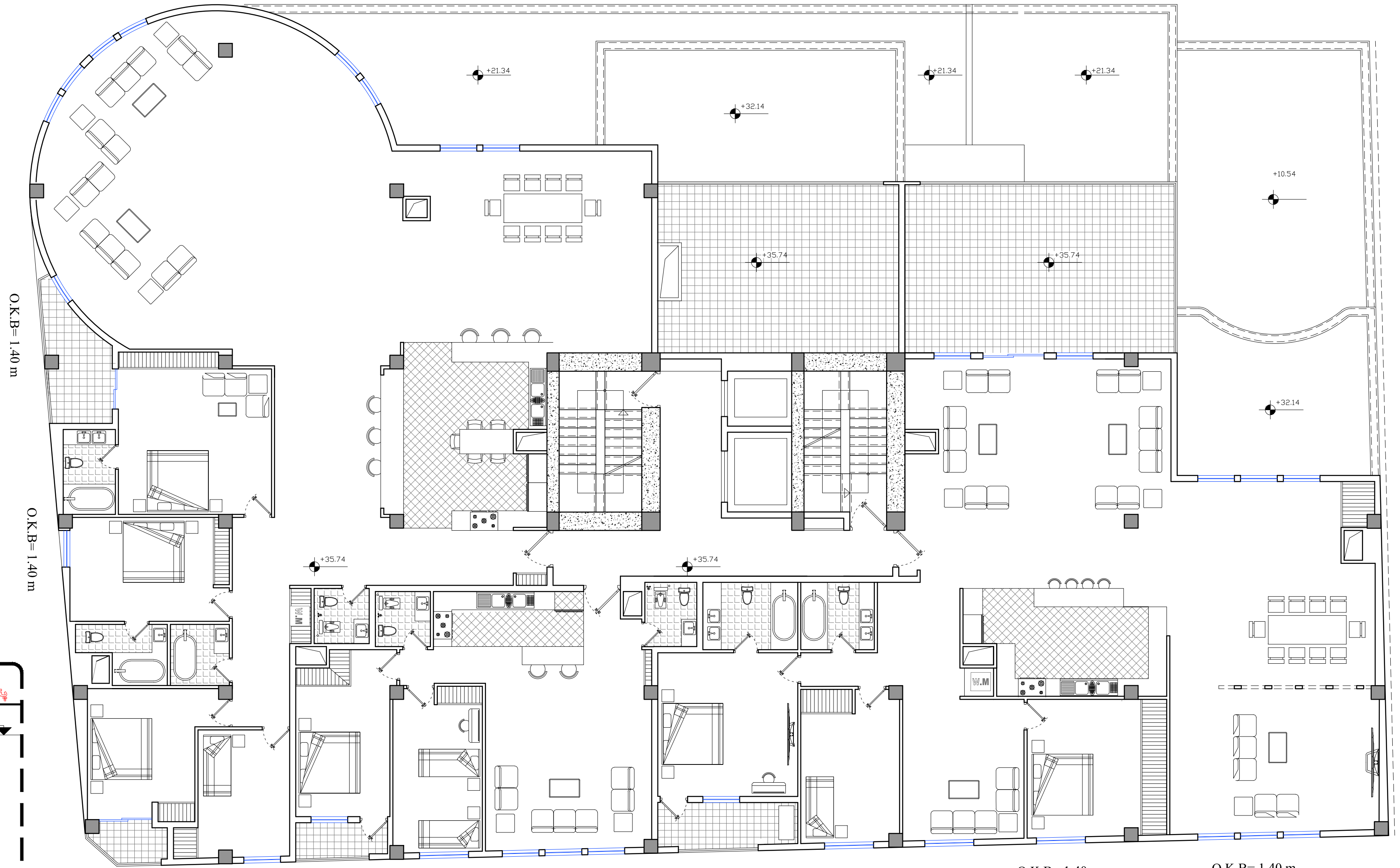
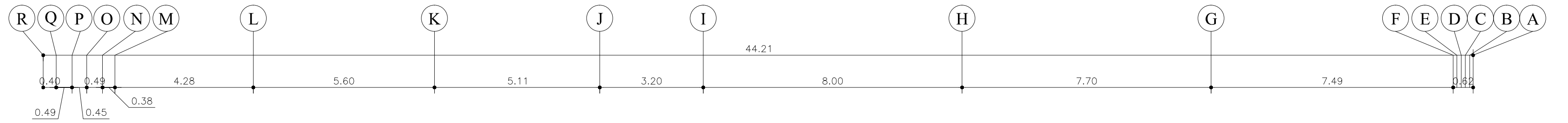
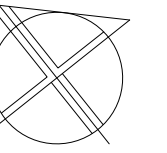

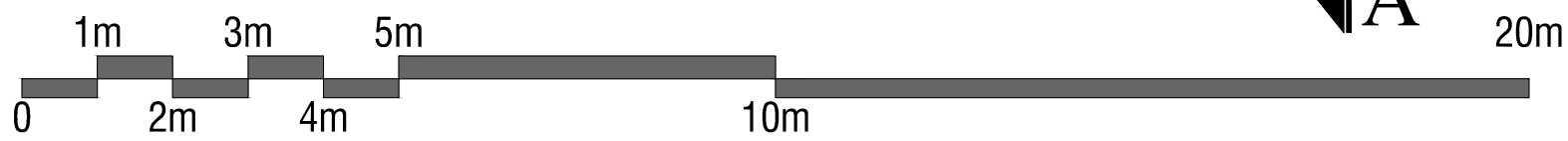
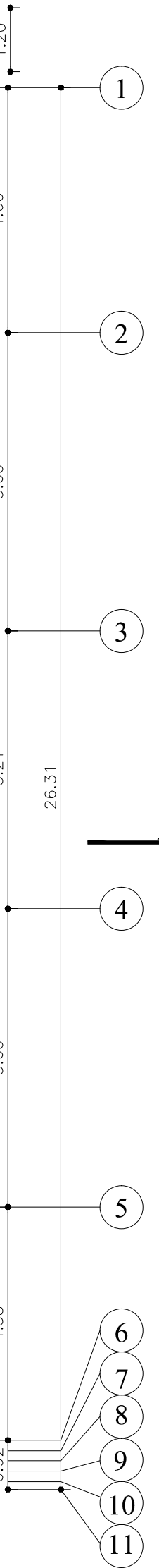
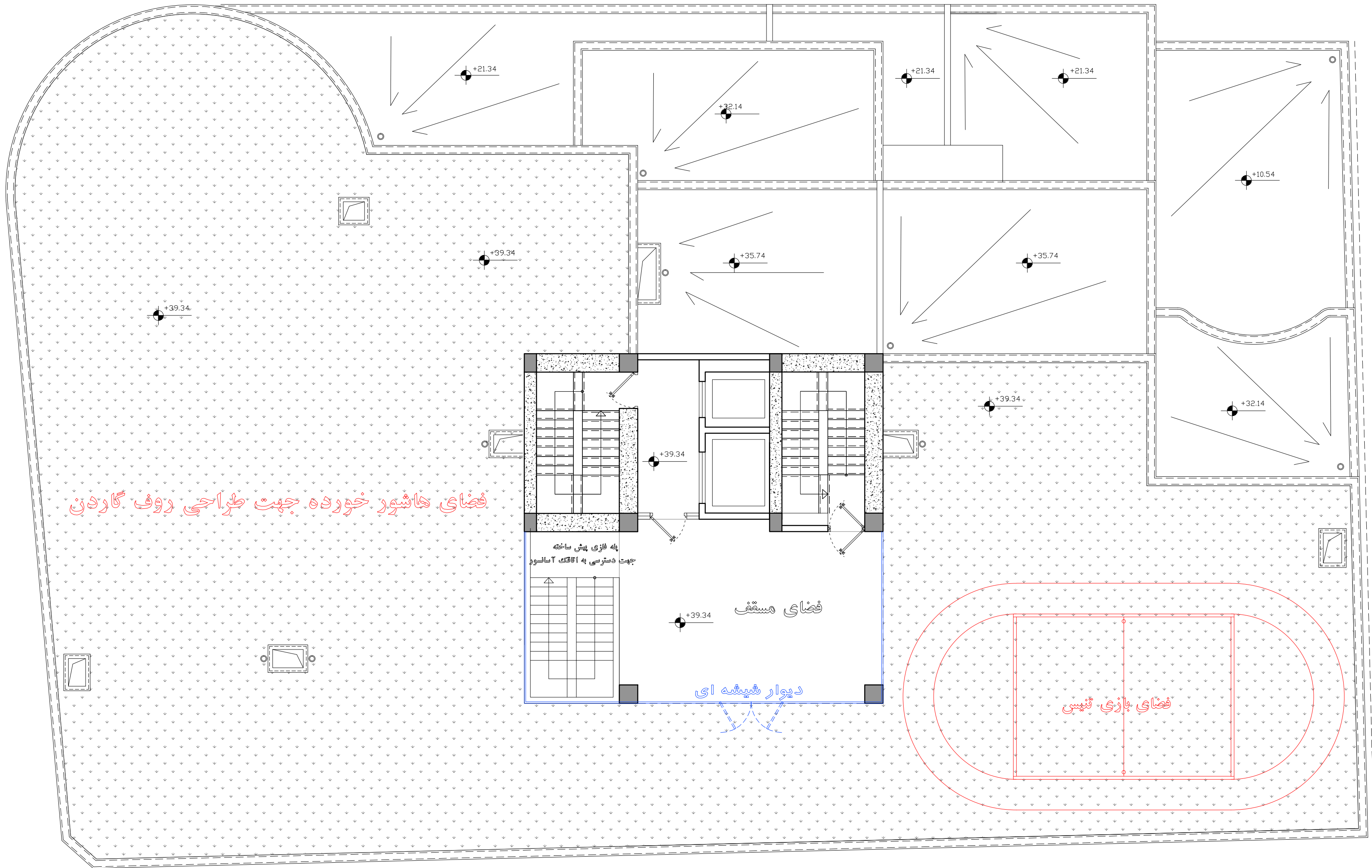
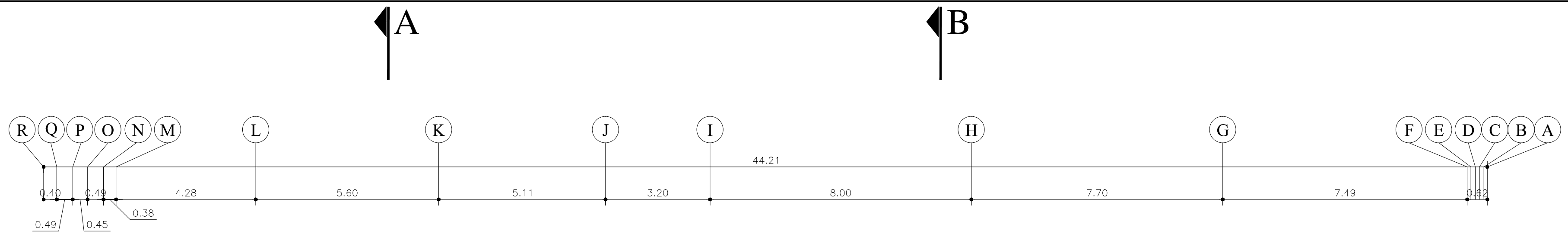
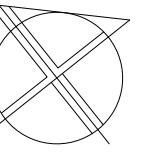

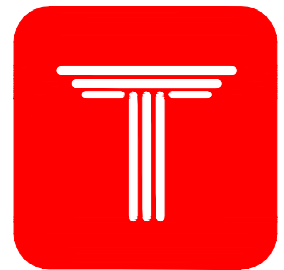

PARK VIEW
COMPETITION

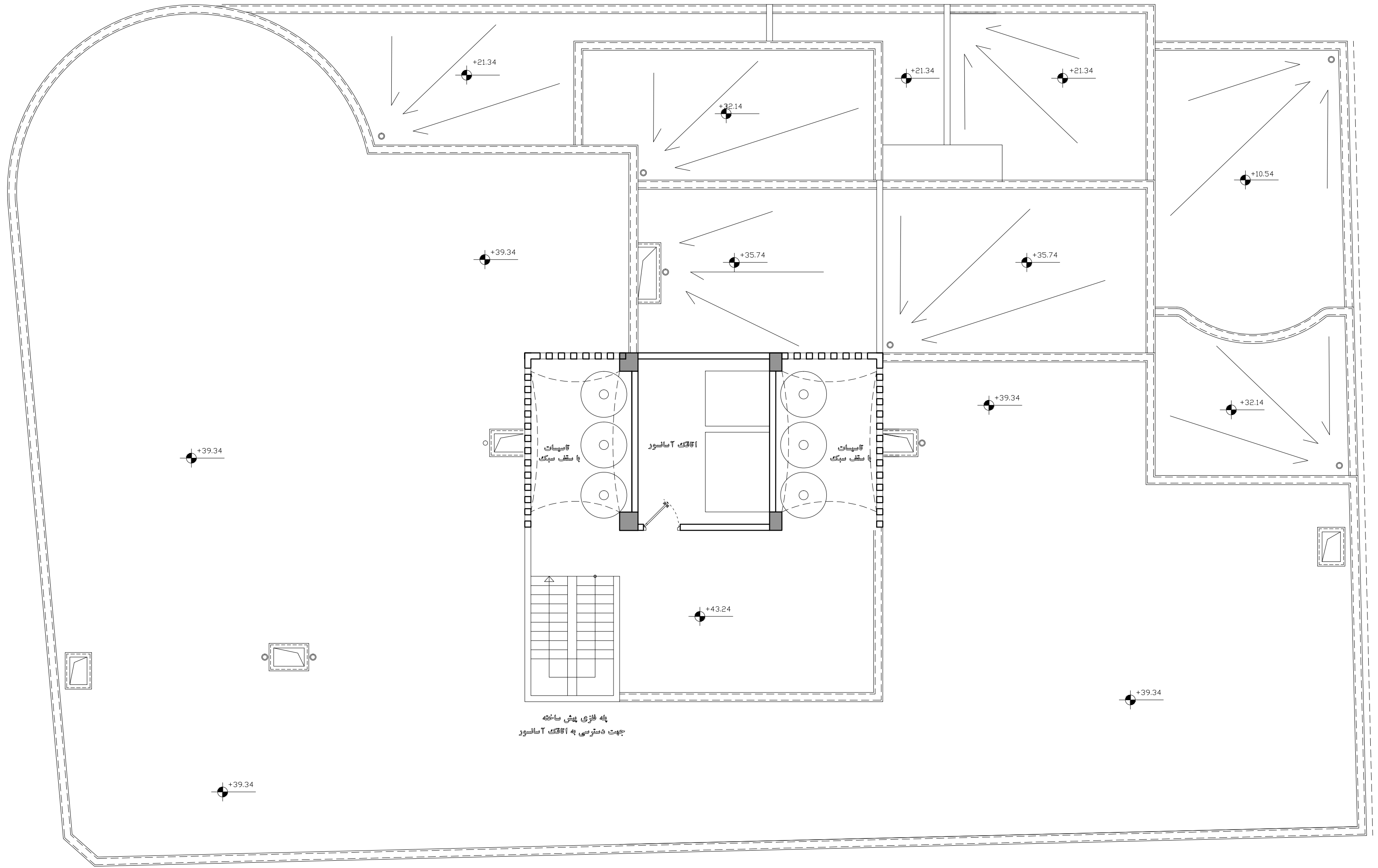
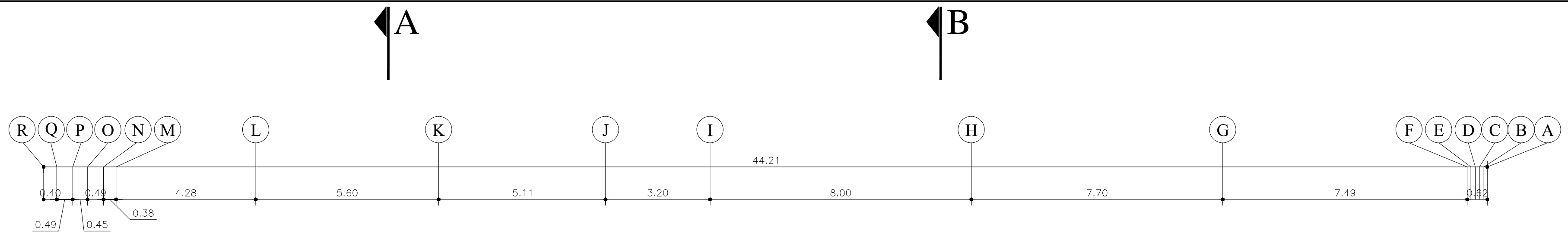
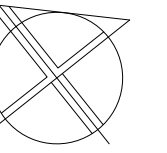

C

C

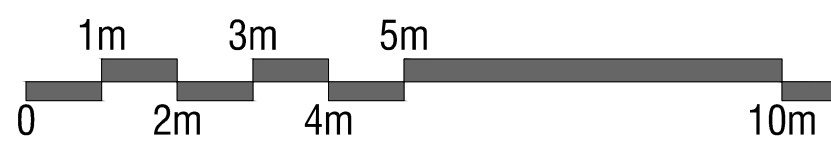

A

B

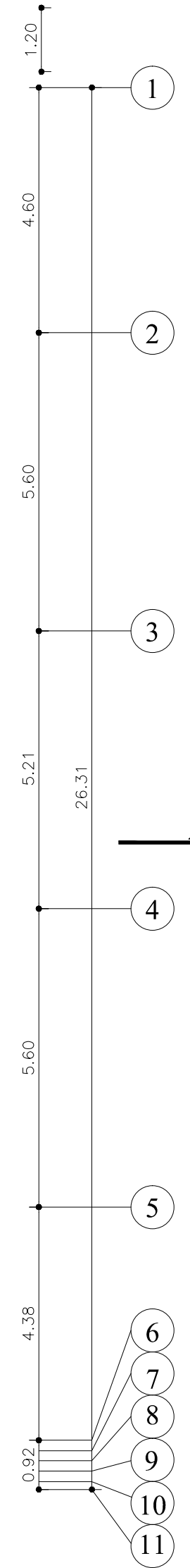

14/19

پلان بام

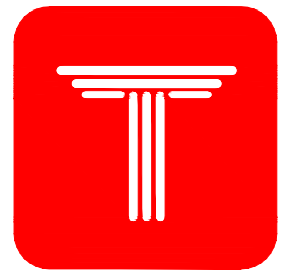

PARK VIEW
COMPETITION

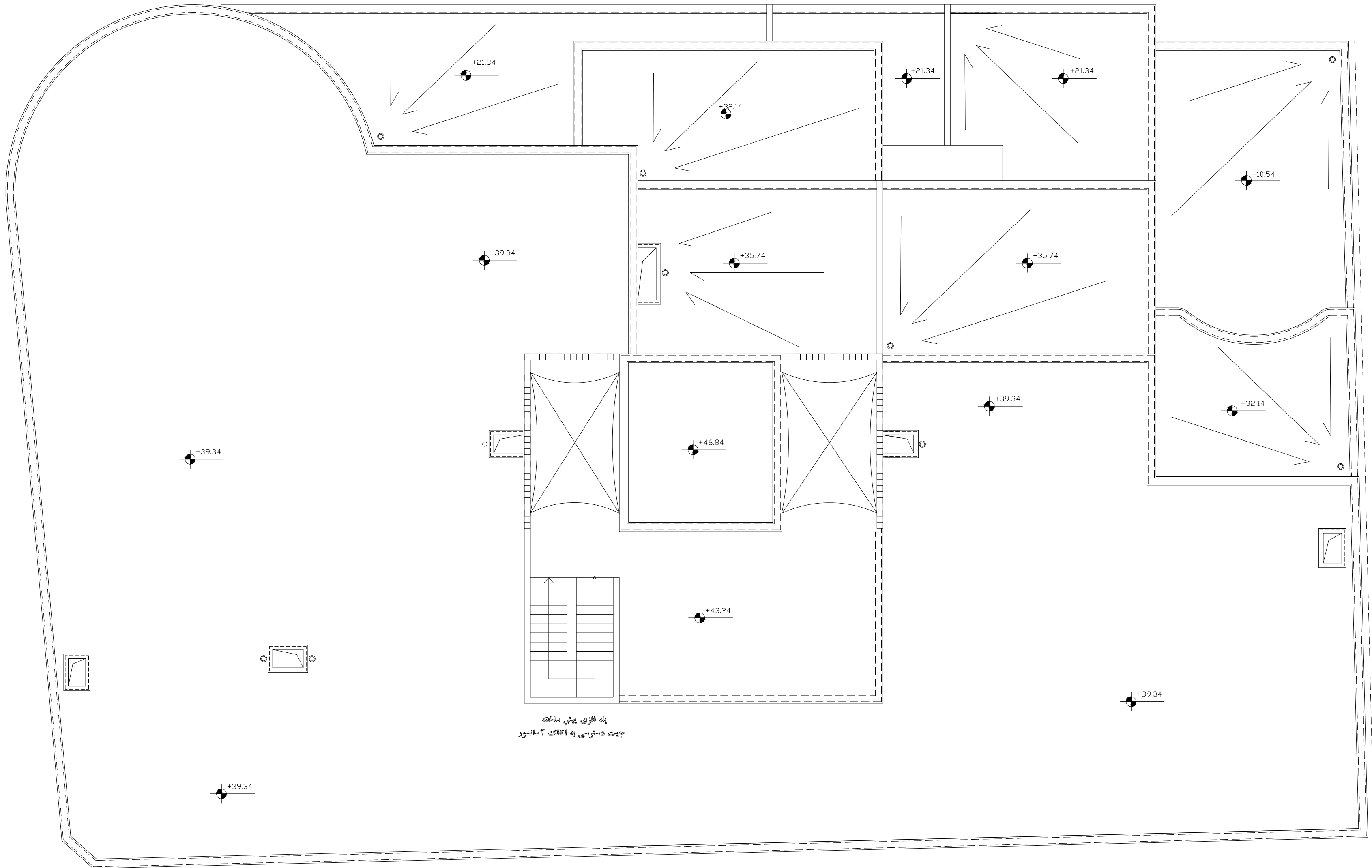
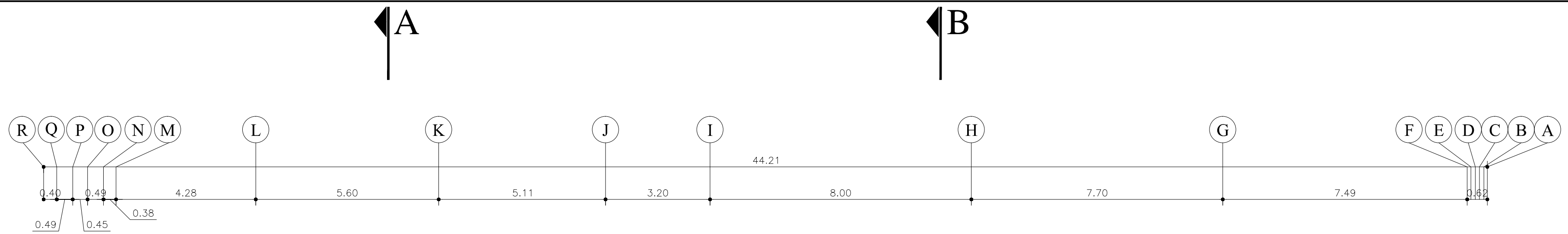
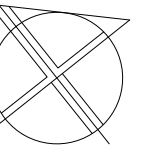

پله فلزی پیش ساخته
جهت دسترسی به اتاق آسانسور

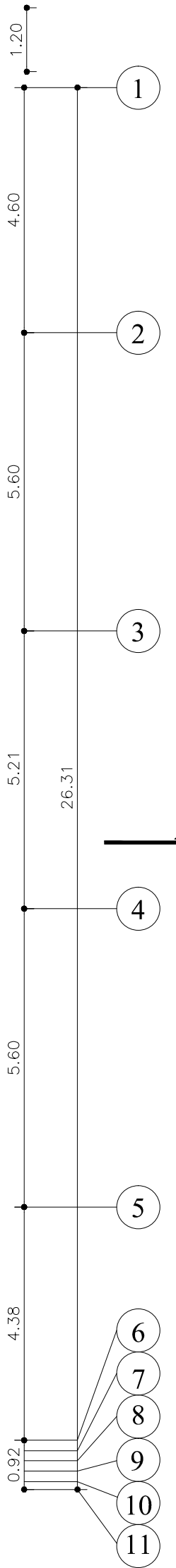

C

C

A

B

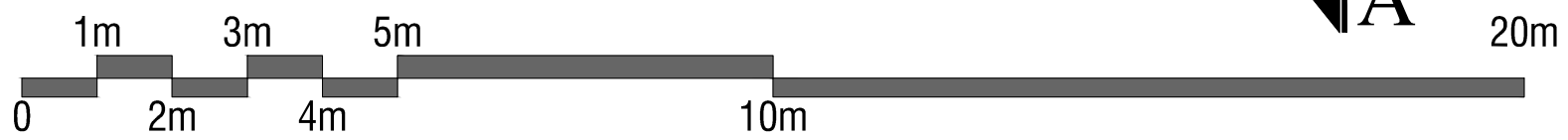

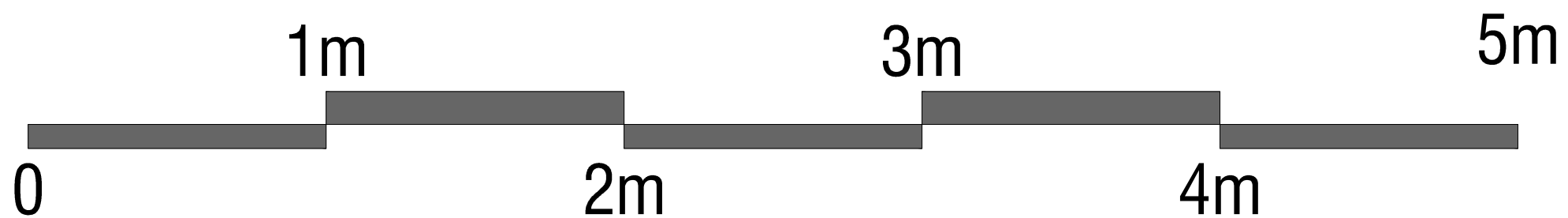
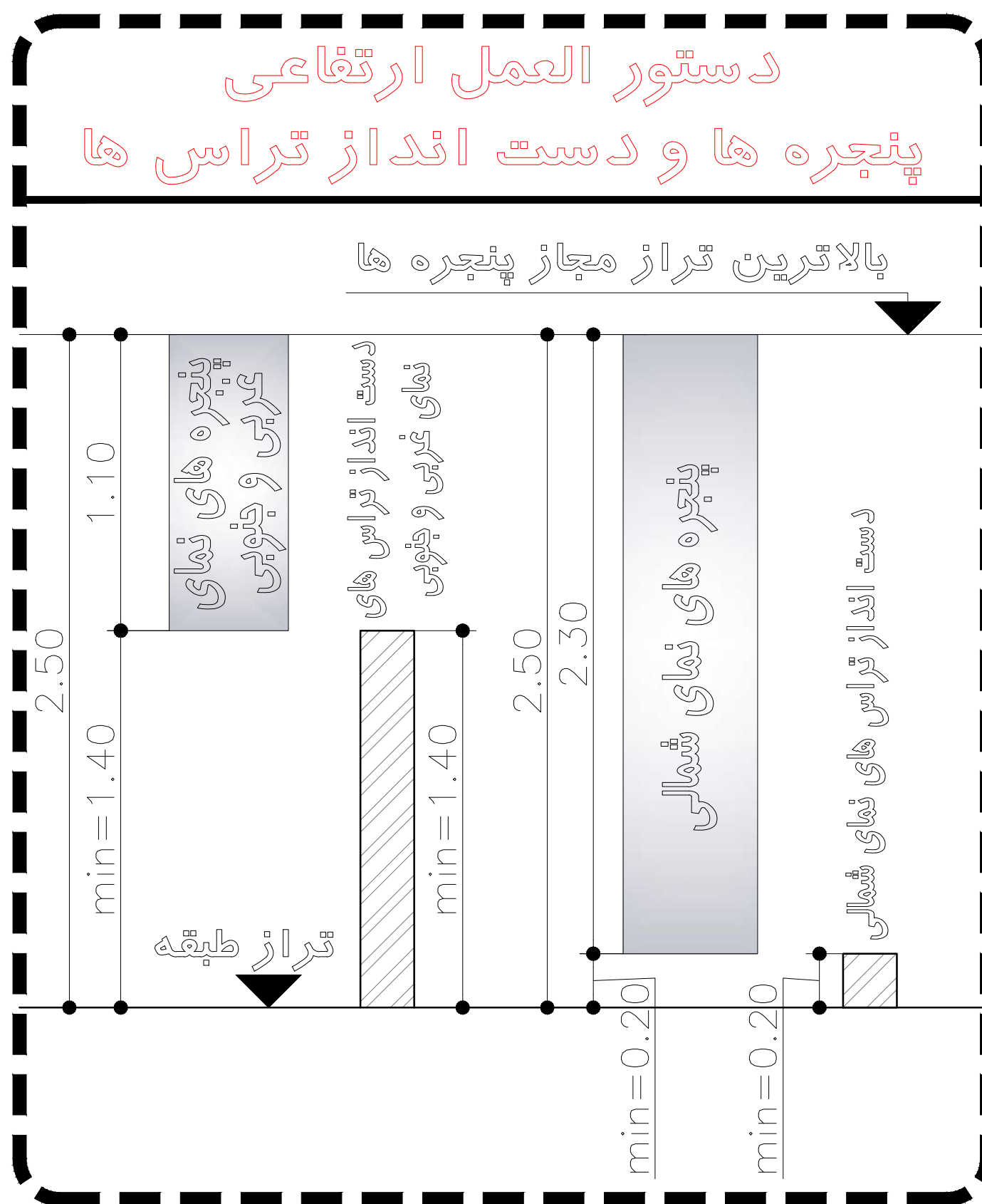

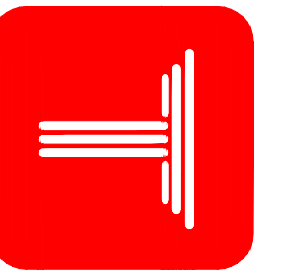

ارتفاع پنجره ها و دست انداز تراس ها در برش ها به صورت شماتیک می باشد.
برای تعیین ارتفاع به دستور العمل موجود در نقشه ها مراجعه فرمایید.

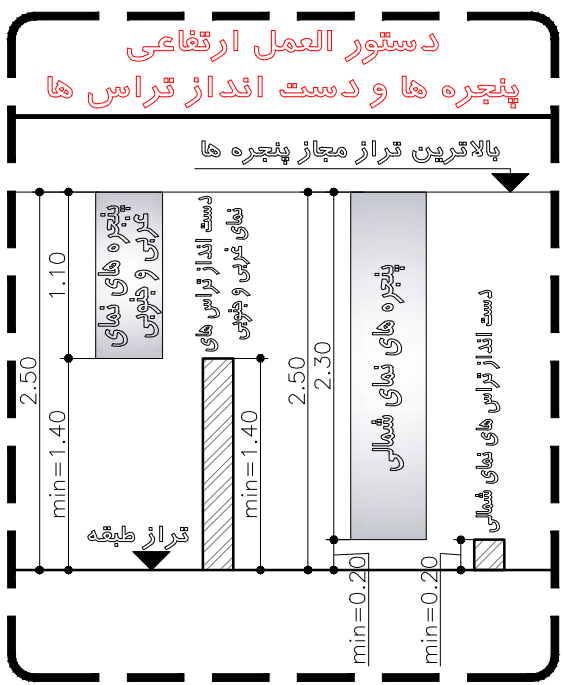
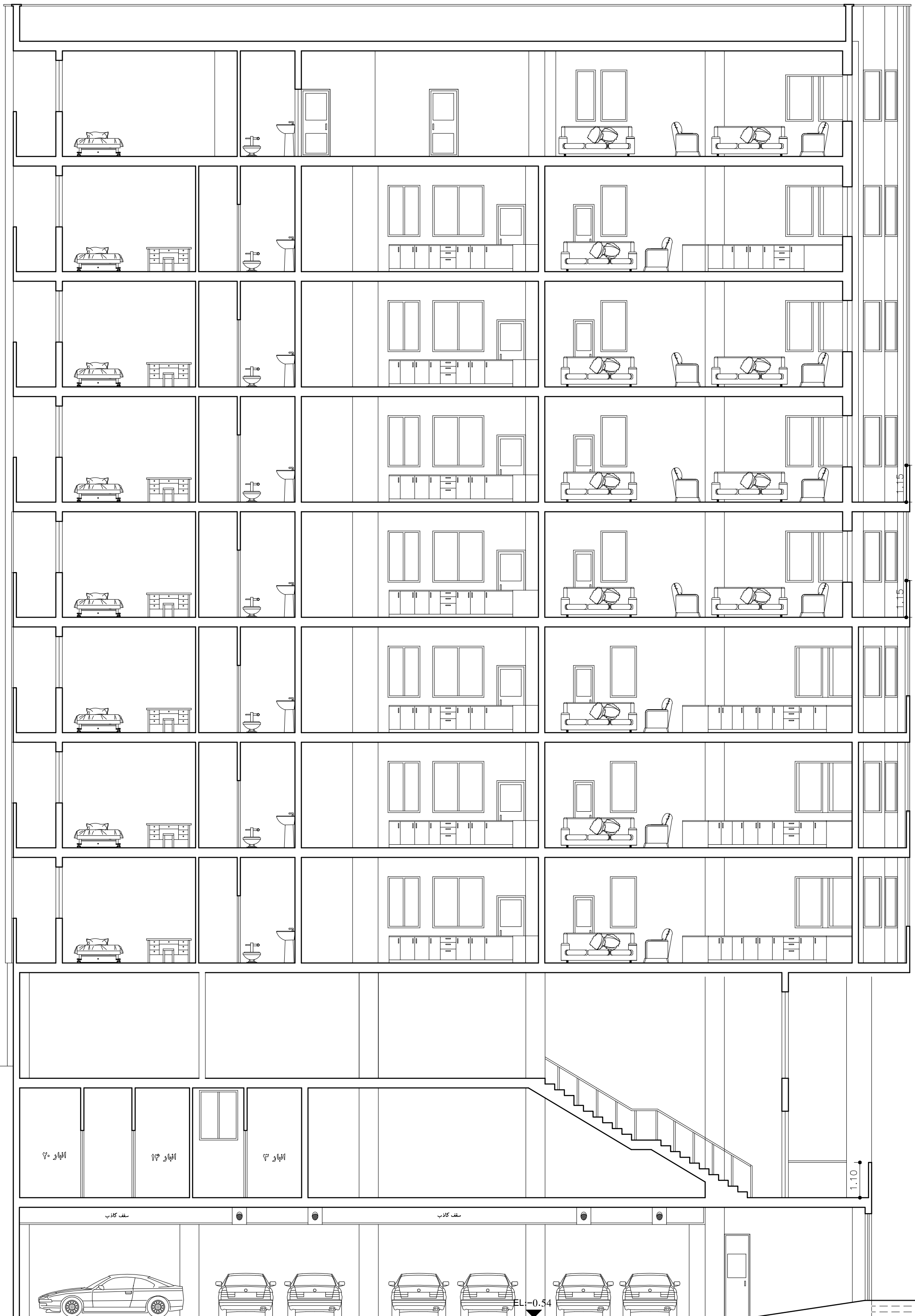
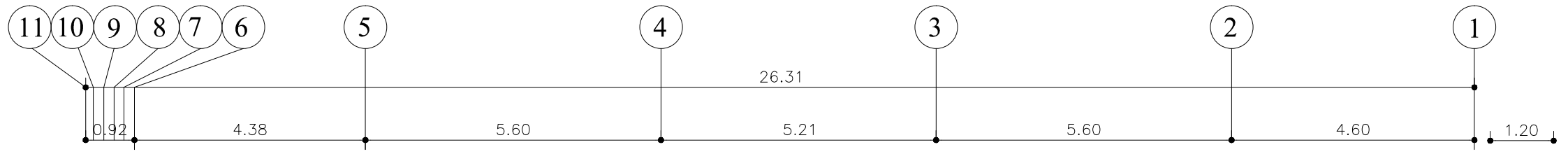
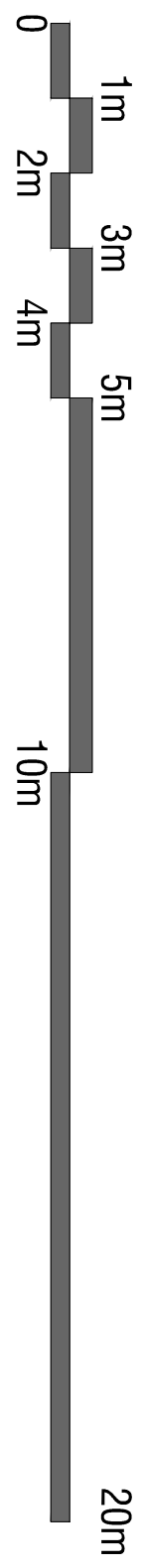

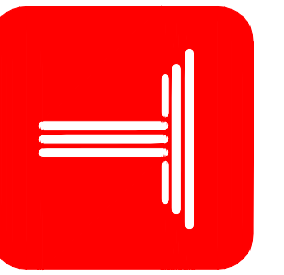

ارتفاع پنجره ها و دست انداز تراس ها در برش ها به صورت شماتیک می باشد.
برای تعیین ارتفاع به دستور العمل موجود در نقشه ها مراجعه فرمایید.

