

BASEMENT-1 FLOOR PLAN

SC. 1:100

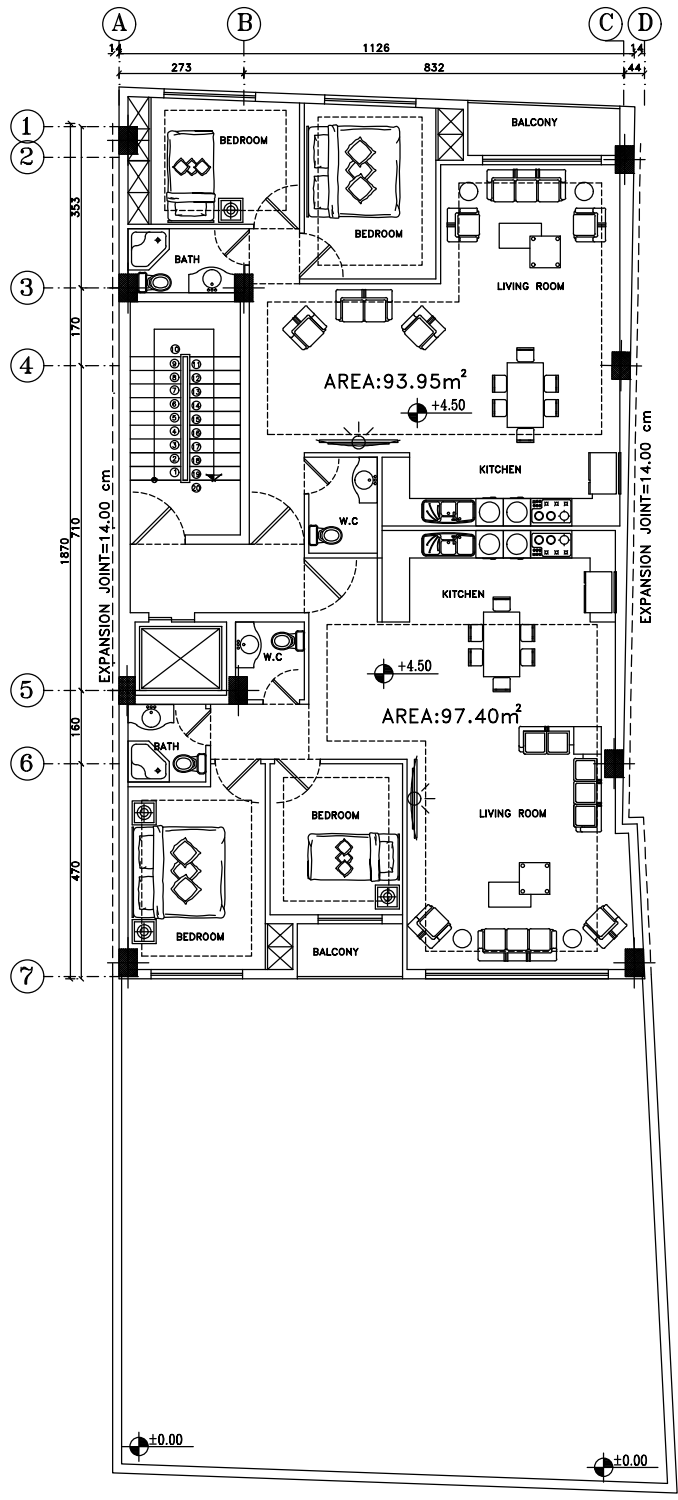

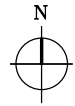

FIRST FLOOR PLAN

SC. 1:100



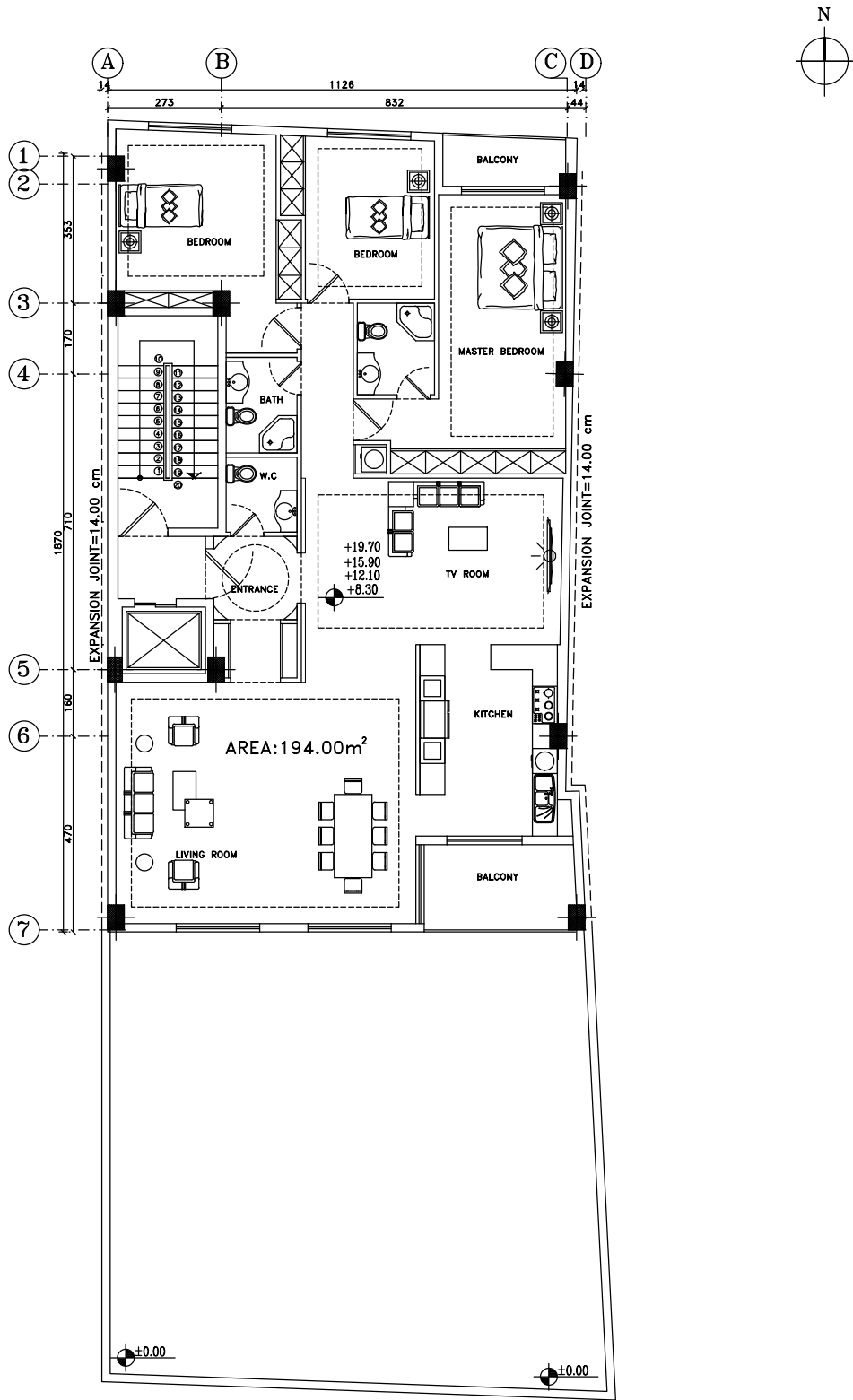

2, 3, 4, 5 FLOOR PLAN

SC. 1:100



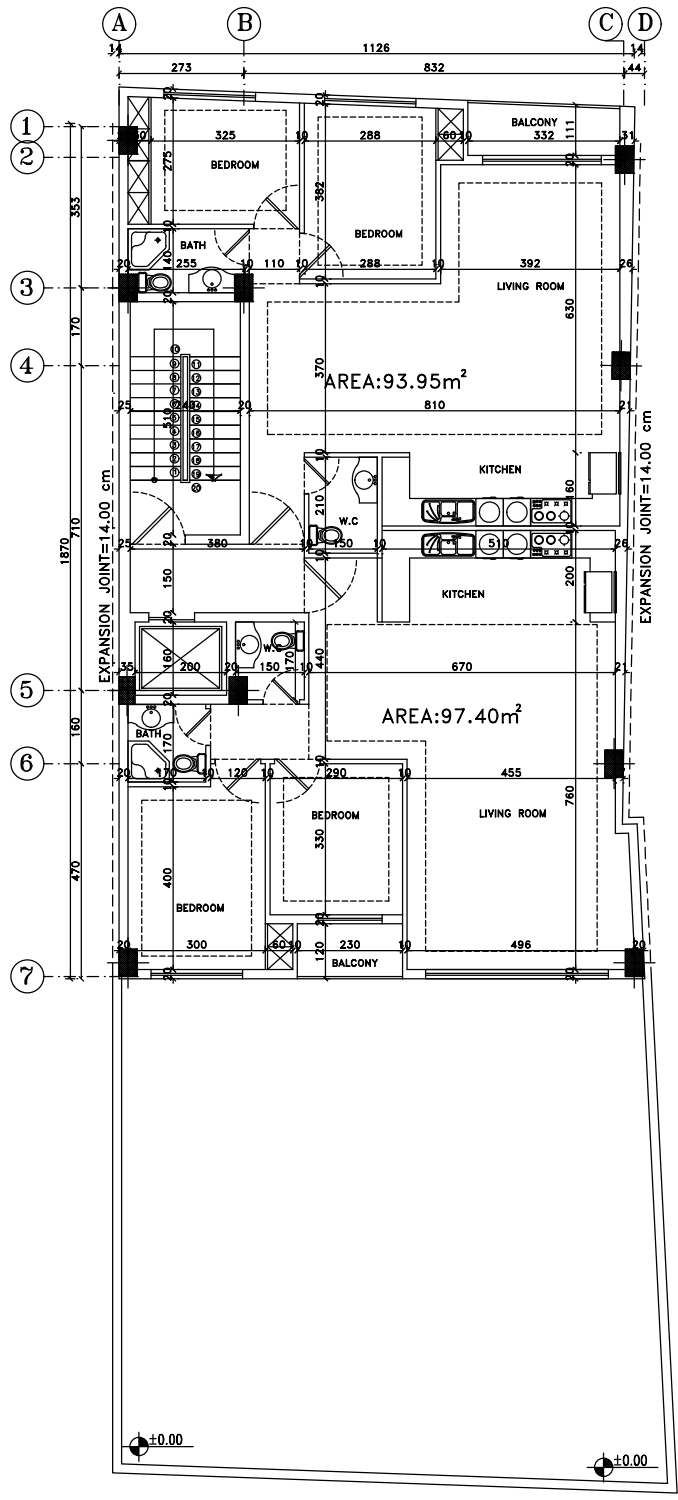
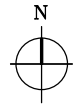

FIRST FLOOR PLAN

SC. 1:100



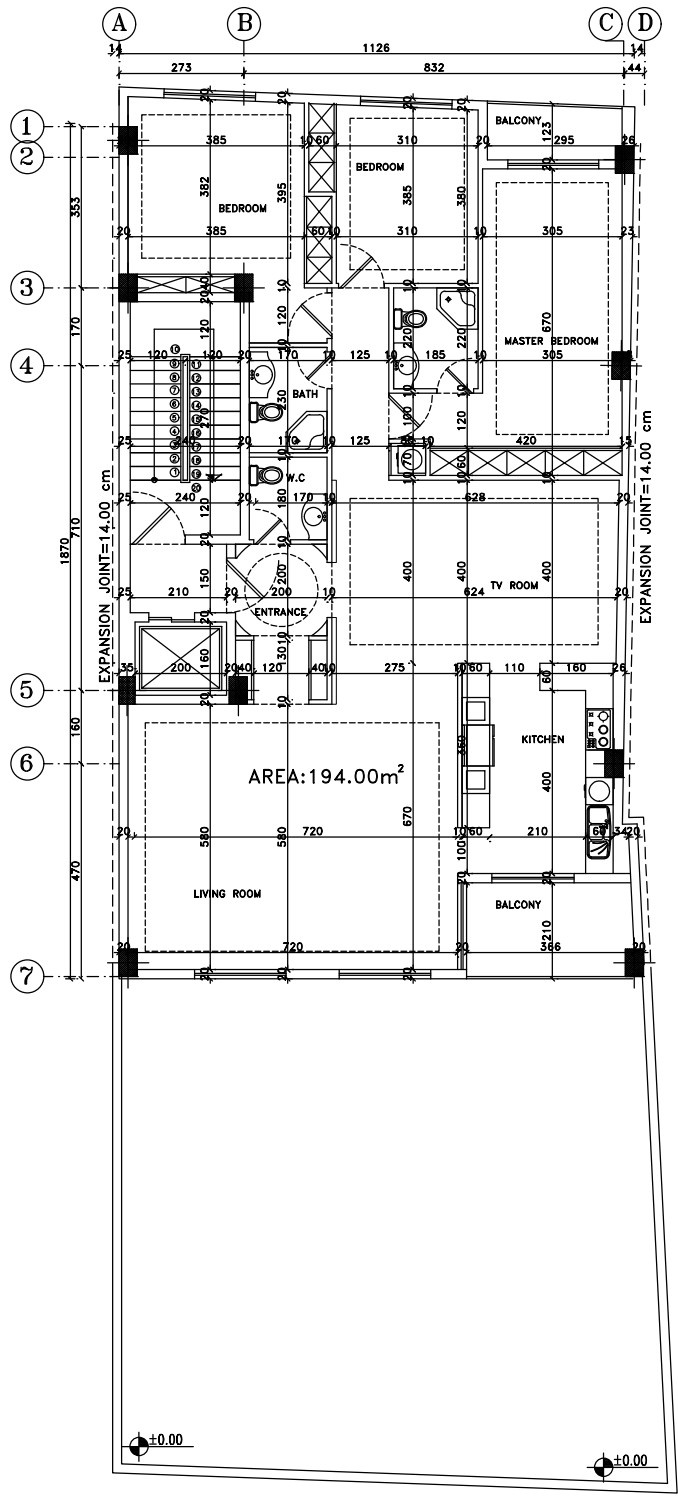
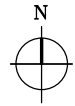

T6

2, 3, 4, 5 FLOOR PLAN

SC. 1:100



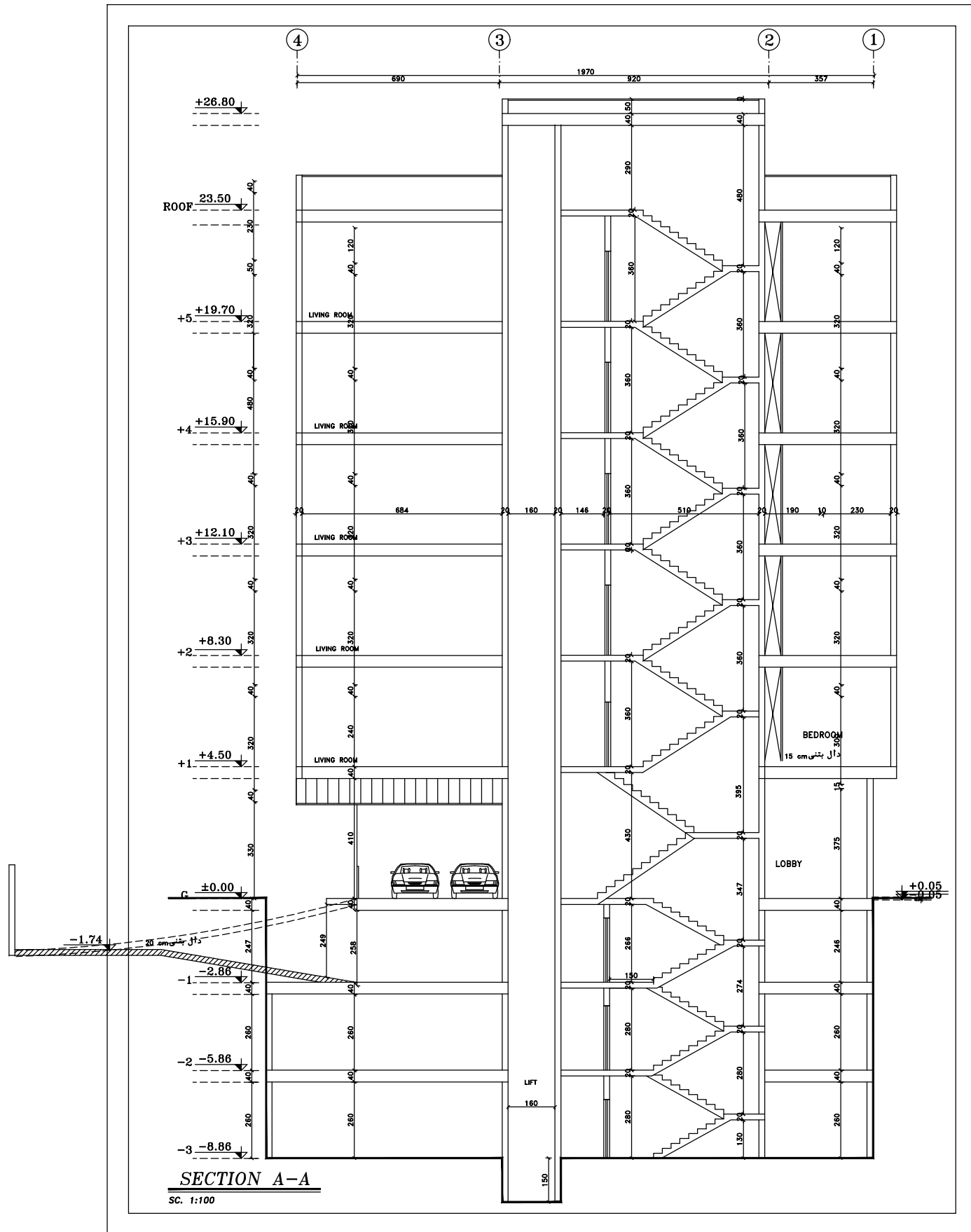

خیابان استانبول گذر ۱۳ متری

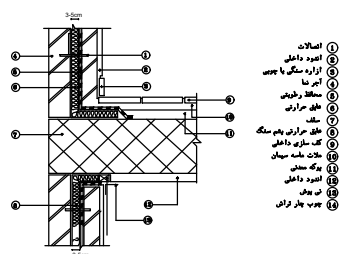
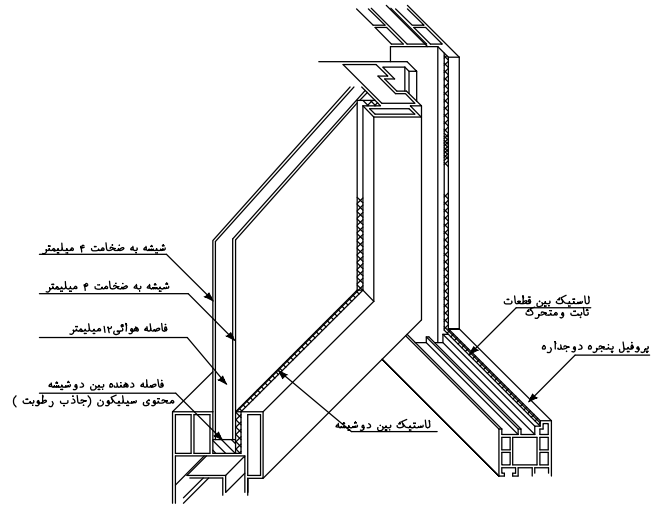
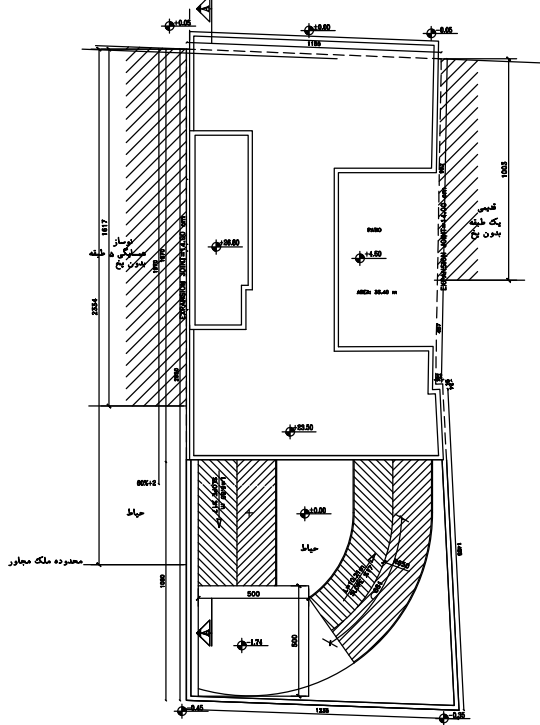

جزئیات عایق حرارتی دیوار جانبی

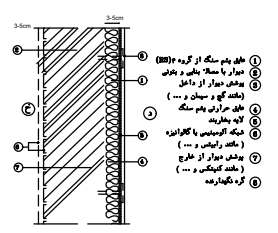

جزئیات عایق حرارتی دیوار خارجی

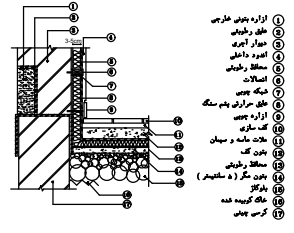

جزئیات عایق حرارتی کف

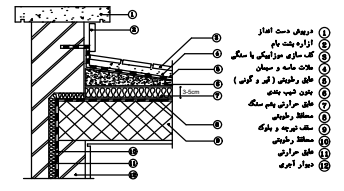

جزئیات عایق حرارتی گوشه بام به دیوار جانبی

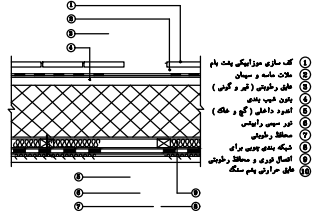

جزئیات عایق حرارتی بام

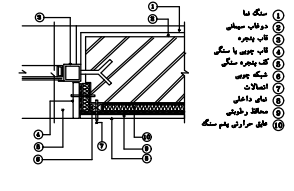

جزئیات عایق حرارتی دیوار به پنجره